

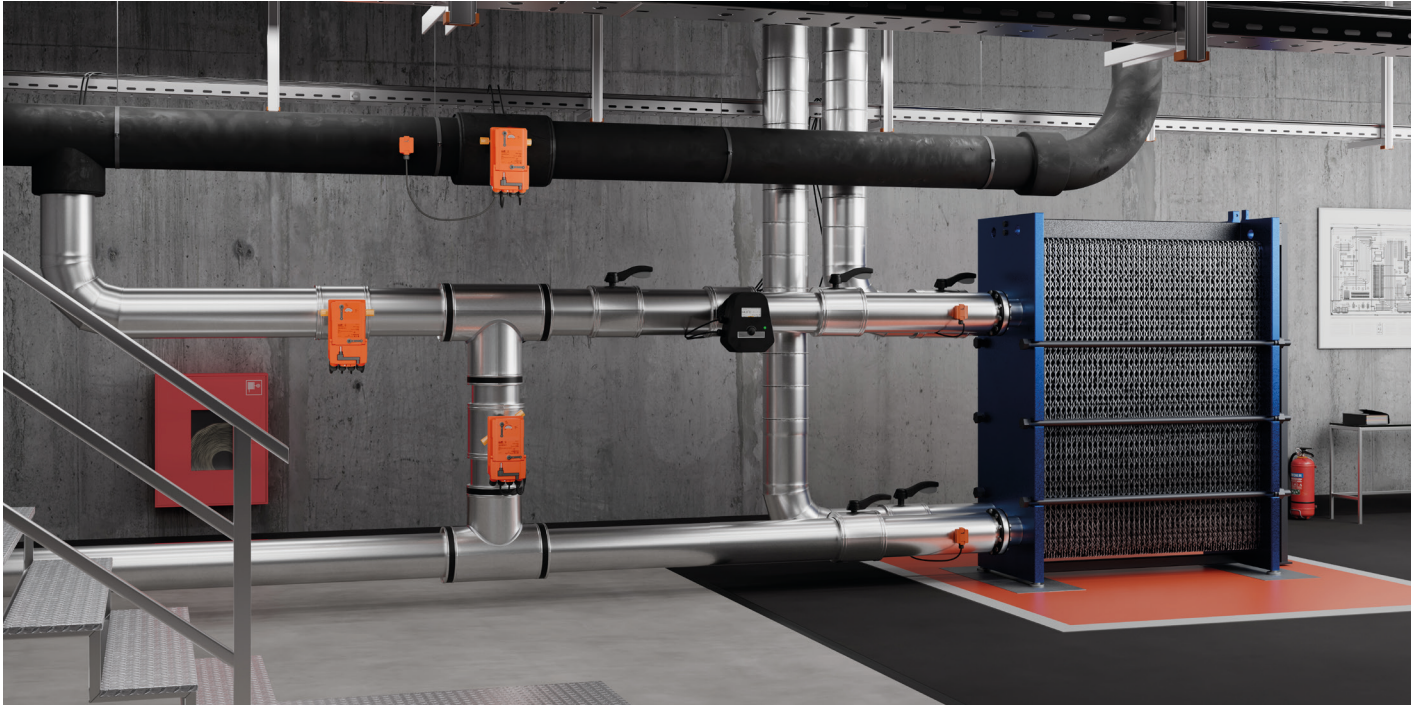

Precise control,  
tight closing.

**Butterfly valves from Belimo**

# Efficiency and reliability in versatile applications.



Control butterfly valves play a crucial role in controlling, tightly closing and changing over high energy flows. They are used in combination with expensive equipment such as refrigeration systems, cooling towers, or heat generation plants. Despite their, compared to the complete system, small size, they have a significant impact on the smooth and energy-efficient operation of these systems.

Our control butterfly valves have been specifically developed for heating, ventilation, and air-conditioning applications, meeting all the requirements. They offer a wide range of options for various applications, including 2-way control and open/close applications with nominal sizes ranging from DN 25 to DN 700, as well as 3-way combinations for control and changeover applications with nominal sizes ranging from DN 100 to DN 300. Furthermore, our intelligent JR and PR actuators with parametrisable linear characteristics enable the reliable use as 3-way control valves in mixing and distribution applications. Additionally, the Belimo Assistant App enables quick and easy commissioning thanks to an intuitive commissioning workflow, as well as flexible parametrisation for a wide range of application possibilities.

Our butterfly valve solutions not only provide easy integration into existing building management systems but can also be put into operation or parametrised within minutes, providing detailed insight into their operating status.



Video – Butterfly valves for control applications

# The latest technology for butterfly valves.

In the Heating, Ventilation and Air-Conditioning sector (HVAC), butterfly valves are fundamental components in virtually every hydronic system.

Most butterfly valves available on the market are less than ideal for this field of application – they leak, their running times are not optimised for HVAC applications, they are too big and heavy for easy mounting, and they cannot be commissioned quickly in the field. Nonetheless, the innovative butterfly valves from Belimo are the exception to this rule and have already proven themselves in countless plants.

The latest technology for butterfly valves from Belimo is primarily for the Heating, Ventilation and Air-Conditioning sector and fully meets the requirements of up to 100%. Belimo is setting new standards here.



## Innovative

Butterfly valves from Belimo are excellently suited for control, open/close and changeover applications. The actuator and the valve design allow a reduction in investment costs as well as energy savings of up to 80%. Intelligent and self-adjusting end stops ensure easy mounting, less commissioning effort, and intelligent torque adaptation over the entire valve lifespan.



## User-friendly

Optimised mechanical layout and easy mount were made possible thanks to the reduced height and weight of the actuator. Flexible visual position indication and the NFC (Near Field Communication) capability enable fast installation, good visibility of the valve position, as well as easy commissioning and troubleshooting, even when the actuator is not connected to the power supply.



## Reliable

Thanks to the 5-year warranty, Belimo is the best choice for your application. Backed with more than 40 years of design experience, the specially designed butterfly valves and the communicative actuators with their long-life brushless DC motor are perfectly coordinated.

"Using the fail-safe actuator from Belimo was not a risk for us. The products from Belimo are convincing for their reliability."

**Darko Zanic, Project Manager**  
**MCR Technology, e-con AG**

"With the communicative PR actuator, we always know how the actuator is doing. With NFC, I was able to commission the PR actuators in just a few minutes from my own smartphone. It is really easy to do and saves a lot of time."

**Andreas Wechner, Project Manager**  
**Trane (Switzerland) GmbH**

# Innovative – user friendly and reliable.

## Equal-percentage or linear valve characteristic curves

are individually parametrisable and enable a constant mixing characteristic curve for 3-way applications.

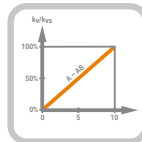

## Near Field Communication (NFC)

enables quick commissioning, configuration and maintenance – even when the actuator is not supplied with voltage.



## Adjustable motor running time

from 20 to 120 seconds, meets the requirements of your application (20 s with JR, 30 s with PR actuator).



## Two temperature sensors

can be connected to the communicative JR and PR actuator.



## IP66/67 housing

enables outdoor use and protects the actuator from UV radiation, rain, snow, dirt, dust and humidity.



## Universal power supply

24...240 V facilitates planning and increases flexibility for all applications.



## 2-way control butterfly valve or open/close butterfly valve with fail-safe

ensure high operating safety in the event of a power failure.





### 3-way control or changeover butterfly valve with JR actuator



#### Intelligent and self-adjusting end stops

ensure easy mounting, less commissioning effort and an intelligent torque adaptation over the entire lifespan of the valve.

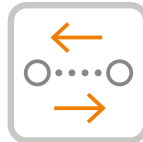

#### Multifunctional and communicative

Not only open/close control and modulating control but also BACnet MS/TP, Modbus RTU and Belimo MP-Bus communication is possible.



#### 80% less power consumption

saves energy and reduces wiring costs.



#### Compact and lightweight construction

of the JR and PR actuators enable simple planning and assembly.



#### Smart heating

prevents condensation in the actuator and increases operating safety and service life.



#### Thermal insulation

avoids condensation in the actuator.



#### Flexible position indication ensures good visibility

and shows the position of the butterfly valve from far away.



#### Leakage rate A, leak-proof

up to 14 bar close-off pressure.

# The added value for you as a Belimo customer.

The innovative butterfly valves from Belimo for control, open/close and changeover applications make life easier and more pleasant for our customers as never before.

## General contractors/Investors

- Rapid amortisation thanks to low investment costs
- Reduced energy consumption
- Reliable control and open/close valve with 5-year warranty



## Consulting engineer

- Flexible utilisation options such as control, open/close and changeover butterfly valve
- Precise design thanks to variable  $K_{vs}$  values of the control butterfly valves from Belimo
- Selectable equal-percentage or linear characteristic curve, parametrisable with the Belimo Assistant App
- Free choice of control (BACnet, Modbus, MP-Bus or analogue signal), adjustable running time, fail-safe option and universal power supply from 24 to 240 V
- Planning flexibility thanks to compact and lightweight construction
- Reduced energy consumption



## System integrators

- Diagnostics and application data access with BACnet or Modbus
- Seamlessly integrated temperature measurement using two integrated measurement inputs for active or passive temperature sensors
- Free choice of control (BACnet, Modbus, Belimo MP-Bus or analogue signal), adjustable running time, fail-safe option and universal power supply from 24 to 240 V
- You can find additional benefits during commissioning on the next page



## Specialist wholesalers

- Available as control, open/close or changeover butterfly valve
- Application flexibility through free choice of control (BACnet, Modbus, MP-Bus or analogue signal), adjustable running time, fail-safe option and universal power supply from 24 to 240 V
- Reliable control and open/close valve with 5-year warranty



## Installers/Plant manufacturers

- Pleasant handling thanks to compact and lightweight construction
- Rapid assembly through ingenious valve-actuator combination involving only a few screws and practical hand grip on the actuator
- Simple position determination through the readily visible position indication
- Additional commissioning benefits can be found below



## Building owners

- Reduced energy consumption
- 0% leakage with up to 14 bar close-off pressure (leakage rate A, tight)
- Reliable operation over the entire service life of the valve
- Easy adaptations to power changes or plant extensions possible



## Operator, facility manager

- Simple position determination through the readily visible position indication
- Simple diagnostics and parameter adaptation with the Belimo Assistant App
- Seamlessly integrated temperature measurement using two integrated measurement inputs for active or passive temperature sensors
- Reliable control and open/close valve with 5-year warranty
- Maintenance-free



## Commissioning

- Rapidly accessible, simple to actuate terminals for the electrical connection
- Simple, time-saving commissioning, configuration and diagnostics with the Belimo Assistant App via NFC, even when de-energised
- Intuitive commissioning workflow with the Belimo Assistant App

# The unique control butterfly valves from Belimo.

## Teaching the butterfly valve how to control

Thanks to the clever interaction between the innovative butterfly valves from Belimo and the intelligent JR and PR actuators, Belimo has taught butterfly valves in nominal sizes DN 100...300 precise control with selectable equal-percentage or linear characteristic curves. Parameterisation of the characteristic curve can be accomplished very simply with the Belimo Assistant App via NFC.

To achieve a linear characteristic curve with a butterfly valve, the S-shaped valve characteristic curve typical for butterfly valves must be corrected. The opening angle must be adjusted according to the specified control signal to achieve the desired flow rate. The intelligent actuators of the control butterfly valves from Belimo make this possible by automatically adjusting the control angle and moving the valve to the required position. This reliably ensures a linear characteristic curve and smooth control characteristics.

In addition, the Belimo Assistant App can be used for flexible adjustment of the maximum opening angle of the valve (its max. position) and thereby also the  $K_{vs}$  value of the control butterfly valve for perfect matching with the respective application.

## The 3-way control valve – redefined

The 3-way control butterfly valve from Belimo is comprised of two 2-way control butterfly valves with linearly parametrised characteristic curves. Both control butterfly valves can be controlled with the same control signal; only one of the two control butterfly valves must be parametrised in such a way that it processes the control signal in an inverted fashion. Thanks to the parametrisable linear characteristic curve of the two 2-way control butterfly valves, a perfect mixing characteristic curve results from their interaction as a 3-way control butterfly valve.

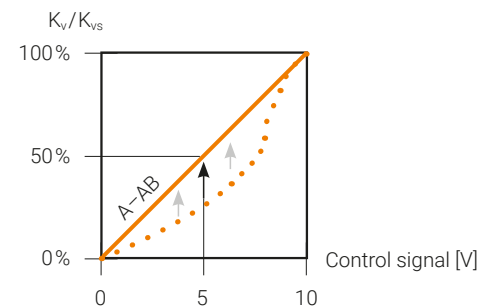

A control butterfly valve with a linearised characteristic curve thanks to the intelligent actuator, parametrisable with the Belimo Assistant App.

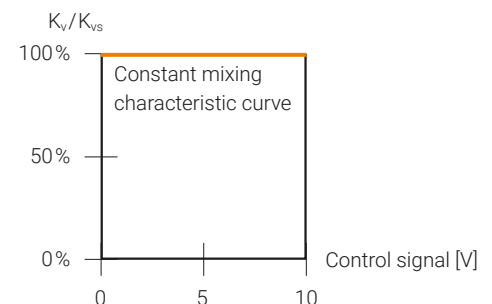
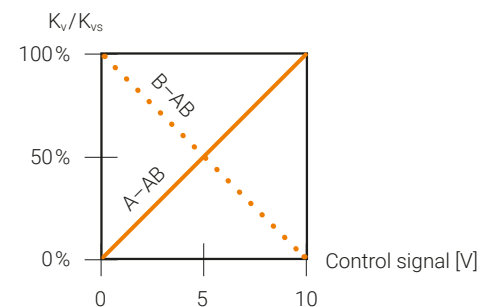

The linear characteristic curve in the control path and the inverse linear characteristic curve in the bypass yield a constant mixing characteristic curve.

# M600 – the new microchip for HVAC actuators.

The microchip acts as the brain of the product and supplies the intelligence of the actuator. The new M600 from Belimo, with multiple patented technologies, offers higher computing power, thus enabling smooth operation and extended functions. This synergy results in a control butterfly valve that not only acts with increased precision but also adapts intelligently to dynamic conditions and contributes to overall flexibility, efficiency and reliability.



## Innovative

Experienced engineers specially developed the innovative M600 high-performance chip for actuators for the HVAC sector. It enables new functions and takes control butterfly valves from Belimo to the next level.



## Precise

Thanks to the intelligent motion control of the M600, precise positioning is possible during both slow and fast movements, as well as while moving into a standstill.



## Efficient

The clever design of the M600 and optimised structure result in a very efficient microchip. This means that it is not only precise, but that it also reduces power consumption to a minimum.



## Future-proof

The M600 opens up new possibilities and provides space for further new functions. For example, in the future we will be able to calculate the current torque of the actuator and record the torque curve. With this, Belimo is taking a further step toward predictive maintenance.

"With the new high-performance chip for HVAC actuators, Belimo is again demonstrating its pioneering spirit and providing significant added value for the HVAC market with its unique control butterfly valve. The control butterfly valve will replace conventional control valves for high flow rates in the medium term."

**Rakip Sabani, Professional building technology instructor, Swiss Technical College in Winterthur**

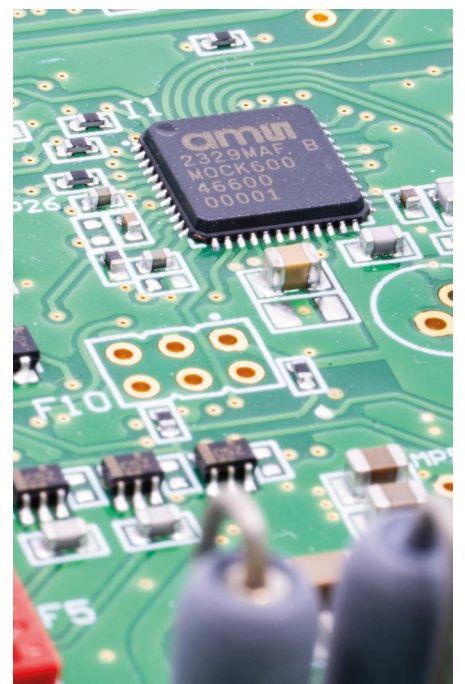

# Flexible for every application.

The butterfly valves from Belimo can be used universally as tight-closing 2-way and 3-way valves for control, open/close, and changeover applications, thus also as mixing and diverting valves. This flexibility is guaranteed by the energy-efficient and multifunctional JR and PR actuators for DN 100...300 butterfly valves. Additional 2-way butterfly valves for control and open/close applications are available in the diameters DN 25...700.



## Butterfly valves from Belimo



	2-way open/close butterfly valve	2-way control butterfly valve	3-way changeover valve	3-way control butterfly valve
Diameters	DN 25...700		DN 100...300	
Control	Open/close	2...10 V, 0.5...10 V, 4...20 mA, 3-point	Open/close	2...10 V, 0.5...10 V, 4...20 mA, 3-point
Flange	Wafer-type or lug-type flange		Lug-type flange	
Communication	–	BACnet MS/TP, Modbus RTU, Belimo MP-Bus or conventional		

## 100% tight for generating cold and heat

The Belimo wafer-type or lug-type control butterfly valves are tried and trusted, tight-closing valves – with up to 14 bar close-off pressure (leakage rate A, tight). In addition to motorisation with rotary actuators from Belimo, the control butterfly valve is also available with lever or worm gear.

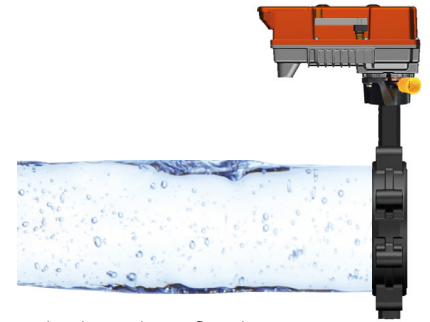

Tight-closing butterfly valve

## Flexible utilisation options

Control butterfly valves can be installed in any direction of flow in the pipeline. In the case of the 3-way control butterfly valve, the installation at the T-piece is also according to preference, which means that the product is for universal utilisation with changeover and control applications and can be used not only as a mixing valve but also as a diverting valve.

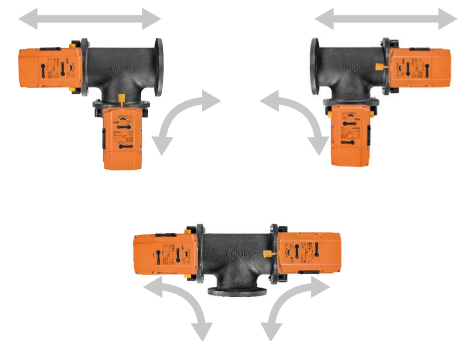

## Transparent communication

The butterfly valve actuators can be configured via the Belimo Assistant App, which means that the control, running time and the maximum opening angle of the valve can be set for each application. Key performance indicators reveal the state of the actuator to guarantee reliable operation.

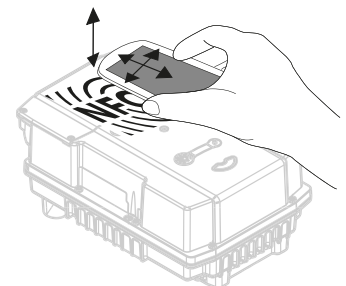

# Specially designed for the HVAC sector.

The butterfly valves and the JR and PR actuators from Belimo are the most intelligent, the most energy-efficient, and the most reliable solution for high flow rates on the HVAC market. Having focused on ease of installation, application flexibility and longevity, this series sets new performance standards in the HVAC sector. The butterfly valves from Belimo are the solution for heating, chiller and cooling tower applications, for changeover systems, as well as for control applications in large ventilation systems and bypass applications.

## Straightforward installation

Thanks to the low overall height and reduced weight of the actuator, the JR and PR actuators from Belimo are easy to install and can be mounted on the butterfly valve with just two screws. In addition, the easily accessible connection box and the practical terminals enable quick and convenient wiring.

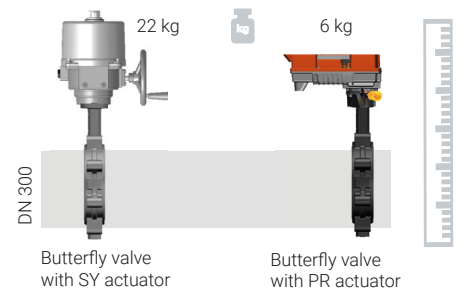

Conventional butterfly valve DN 300

Belimo butterfly valve D6..W/WL DN 300

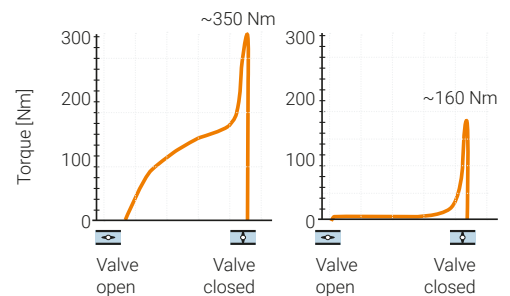

## Up to 80% energy savings

The innovative valve design reduces the torque required to actuate and close the valve over its entire service life. With up to 80% less power consumption, the valve-actuator combination saves energy and reduces transformer and wiring costs.

## Good security

Flexible visual position indication shows the position of the control butterfly valve from far away. At the same time, the linkage functions as thermal insulation, preventing condensation in the actuator.



## Smart heating prevents condensation

Thanks to the integrated temperature and humidity sensor, the built-in intelligent heating only switches on when the ambient conditions require it. This means that the formation of condensation water in the actuator can be prevented.

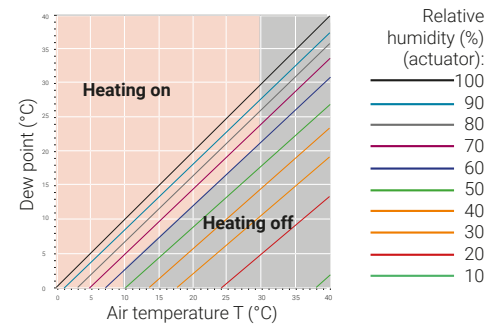

## Communicative actuator for flexible parameterisation

The communicative JR and PR actuators enable expanded data access with diagnostic options and offer flexible parameterisation possibilities: open/close, 3-point, 0.5...10 V, 2...10 V, 4...20 mA, Belimo MP-Bus, Modbus RTU and BACnet MS/TP. With the Belimo Assistant App, the types of control and bus parameters are easy to set using NFC.

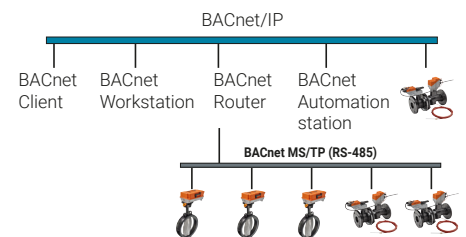

## Seamlessly integrated temperature measurement

The Belimo temperature sensors can be easily connected to the communicative JR and PR actuators, providing a system solution to create an optimised system. Two measurement inputs for active or passive temperature sensors provide accurate measurement data via BACnet MS/TP or Modbus RTU.

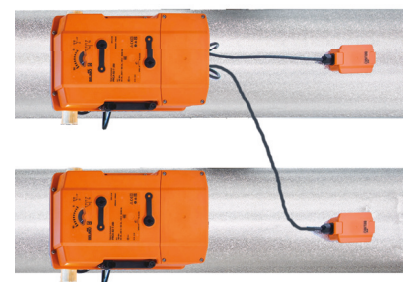

## High level of safety, even during power failures

The fail-safe of the optionally available, reliable PRK actuator enables high operation reliability for your plant. The butterfly valve moves to its specified position in the event of a power failure. This can be set between 0...100% using the Belimo Assistant App.



# Belimo Assistant App. Parameterisation and diagnostics.

The JR and PR actuators can be parameterised easily via smartphone, even if the actuator is not connected to the power supply. The current status of the actuators can be checked at any time using the diagnostic parameters.

## Simple commissioning thanks to NFC

The actuators with NFC enable easy commissioning, parameterisation, and maintenance directly from a smartphone. Application-dependent, predefined settings can be selected quickly and easily and written to the communicative actuators using the Belimo Assistant App and the commissioning workflow available in it. In addition, countless other parameters can be configured flexibly.



Simple commissioning directly via smartphone or the Bluetooth NFC converter ZIP-BT-NFC using NFC.

## Reliable operation guaranteed

Key performance indicators reveal the current state of the actuator to ensure reliable operations. At the same time, numerous diagnostic parameters provide the user with an impression of how the product interacts with the system during ongoing operation. Rapid failure analysis is made possible, should a service call become necessary.

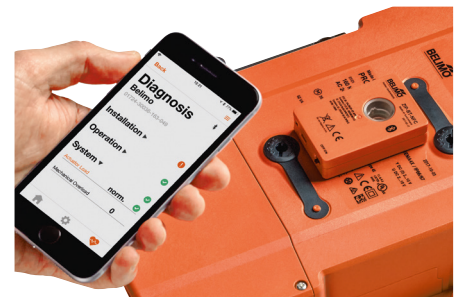

Display of the diagnostic parameters in the Belimo Assistant App.

## Belimo Assistant App

The Belimo Assistant App enables the display, parameterisation and diagnostics for actuators from Belimo and HVAC performance devices with an NFC interface, even when de-energised. Install the app via the App Store or Google Play.



## Valve Sizing and Selection

You can easily find the suitable valve and the right actuator for your application with the convenient valve sizing and selection tool. Simply access it on our website.



# Belimo RetroFIT+ solution for third-party butterfly valves.

Belimo produces universal actuators for motorising existing installations. With the help of simple adapters, these actuators can be mounted on installed butterfly valves from a variety of manufacturers.

## Actuators from Belimo

Whether as standard actuators for open/close or 3-point applications, BACnet actuators for modulating and bus applications, or fail-safe actuators – actuators from Belimo are designed for universal use as retrofit solutions.

## RetroFIT+ linkage

Adapter for connection with third-party butterfly valves and JR or PR actuators from Belimo: ZPR05...ZPR15.



Belimo RetroFIT+ solution with fail-safe, PRK and ZPR linkage.

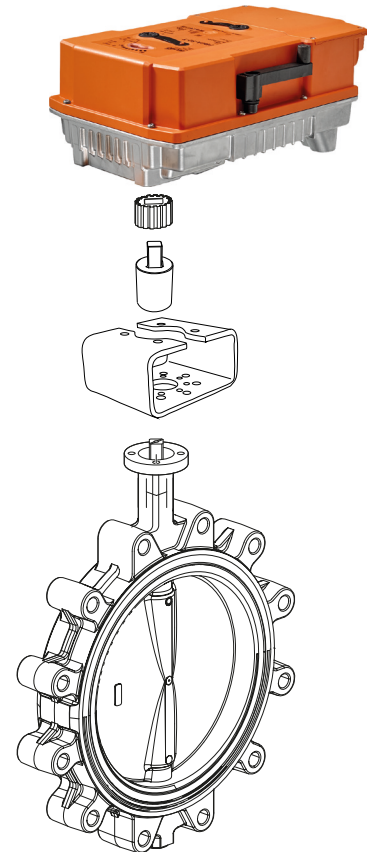

## Belimo RetroFIT+ App

Convenient replacement and modernisation of actuators in existing installations. Install the app via the App Store or Google Play.



## RetroFIT+ Product Replacement Tool

The Product Replacement Tool offers the same functionality as the RetroFIT+ App, browser-based on our website.



# All inclusive.

Belimo as a global market leader develops innovative solutions for the controlling of heating, ventilation and air-conditioning systems. Damper actuators, control valves, sensors and meters represent our core business.

Always focusing on customer value, we deliver more than only products. We offer you the complete product range for the regulation and control of HVAC systems from a single source. At the same time, we rely on tested Swiss quality with a five-year warranty. Our worldwide representatives in over 80 countries guarantee short delivery times and comprehensive support through the entire product life. Belimo does indeed include everything.

The "small" Belimo devices have a big impact on comfort, energy efficiency, safety, installation and maintenance.

In short: Small devices, big impact.



5-year warranty



On site around the globe



Complete product range



Tested quality



Short delivery times



Comprehensive support

